

slim  
ficha técnica  
datasheet

ref. 5550116

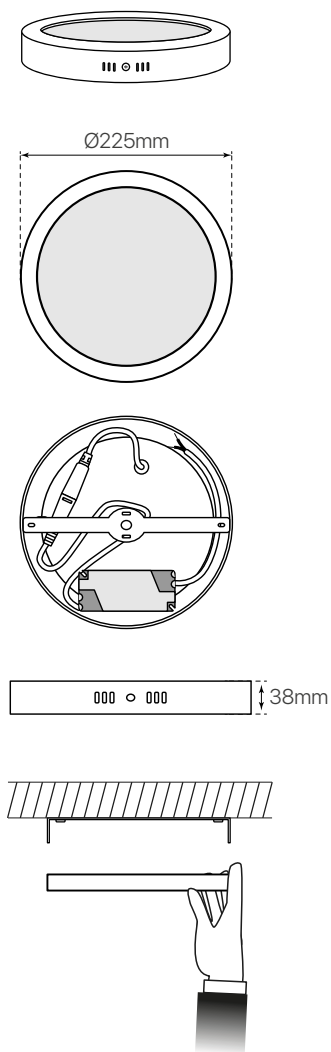

Nombre / Name	Slim • plafón led de superficie redondo
Referencia / Reference	5550116
Materiales / Materials	Aluminio + PMMA / Aluminum + PMMA
Difusor / Diffuser	PMMA
Potencia / Power	20W
Temperatura de color / Color temperature	3200K
Flujo luminoso / Luminous flux	1825lm
Dimable / Dimmable	Opcional / Optional
Ángulo de apertura / Beam angle	110°
Ángulo de detección / Detection angle	-
IP	44
IK	08
F.P	>0.9
UGR	20
IRC	>80
Chip	EPISTAR 2835
Driver	i-TEC series
Vida media ( duración ) / Average life	± 50.000h
Clase energética / Energy class	A++
Aislamiento eléctrico / Electrical isolation	Clase I / Clase I
Colores / Colors	Blanco / White
Medida exterior / Product size	Ø225mm x 38mm
Protección contra Sobretensiones / surge protection	2kv
Tª ( ambiente/trabajo ) / Tª ( enviroment/work )	-20°C ~ 50°C
Input	AC85 ~ 265V
Output	DC36 ~ 72V
Frecuencia / Frequency	50 / 60Hz
Peso / Weight	580g
Certificados / Certificates	CE RoHS
Garantía / Warranty	2 años / 2 years